

For reference only. See data sheet for the detailed specifications.

Technical Specification

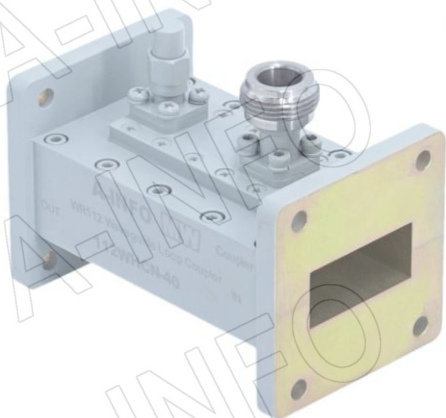

EIA WR	WR112
Frequency Range(GHz)	7.05 – 10.0
Coupling(dB)	40
Directivity(dB)	15 Typ.
Insertion Loss(dB)	0.1 Max. (Not including the theoretical loss 4.34×10^{-4} dB)
Mainline VSWR	1.10:1 Max.
Secondline VSWR	1.35:1 Max.
Flange	FBP84(UBR84)
Coupling Port	N-Female / N-Male
Material	Al
Size(mm)	76.2 x 47.8 x 60.5
Net Weight(Kg)	0.20 Around

Outline Drawing (Size: mm)

Coupling Port: N-Female

For N-Male connector Coupling Port outline drawing, please contact A-INFO.

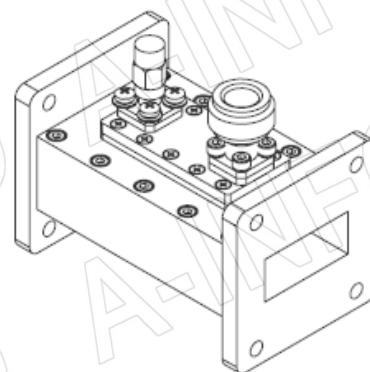
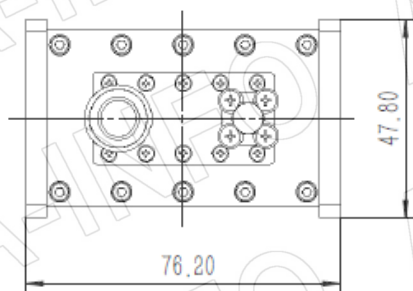
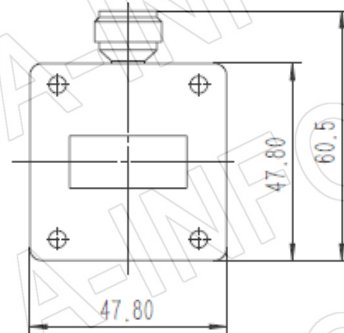
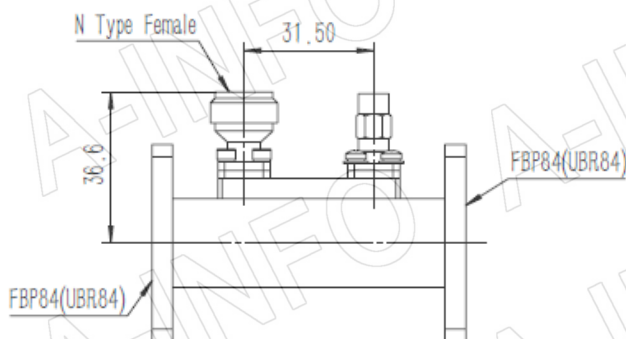

AINFO Inc.

China(Beijing): Tel: (+86) 10-6266-7326,
China(Chengdu): Tel: (+86) 28-8519-2786,
USA: Tel: (+1) 949-639-9688,

Page 1 of 5

(+86) 10-6266-7327 Fax: (+86) 10-6266-7379
(+86) 28-8519-3044 Fax: (+86) 28-8519-3068
(+1) 949-639-9608 Fax: (+1) 949-639-9670

Website: www.ainfoinc.com
Email: sales@ainfoinc.com

Flange Drawing (Size: mm)

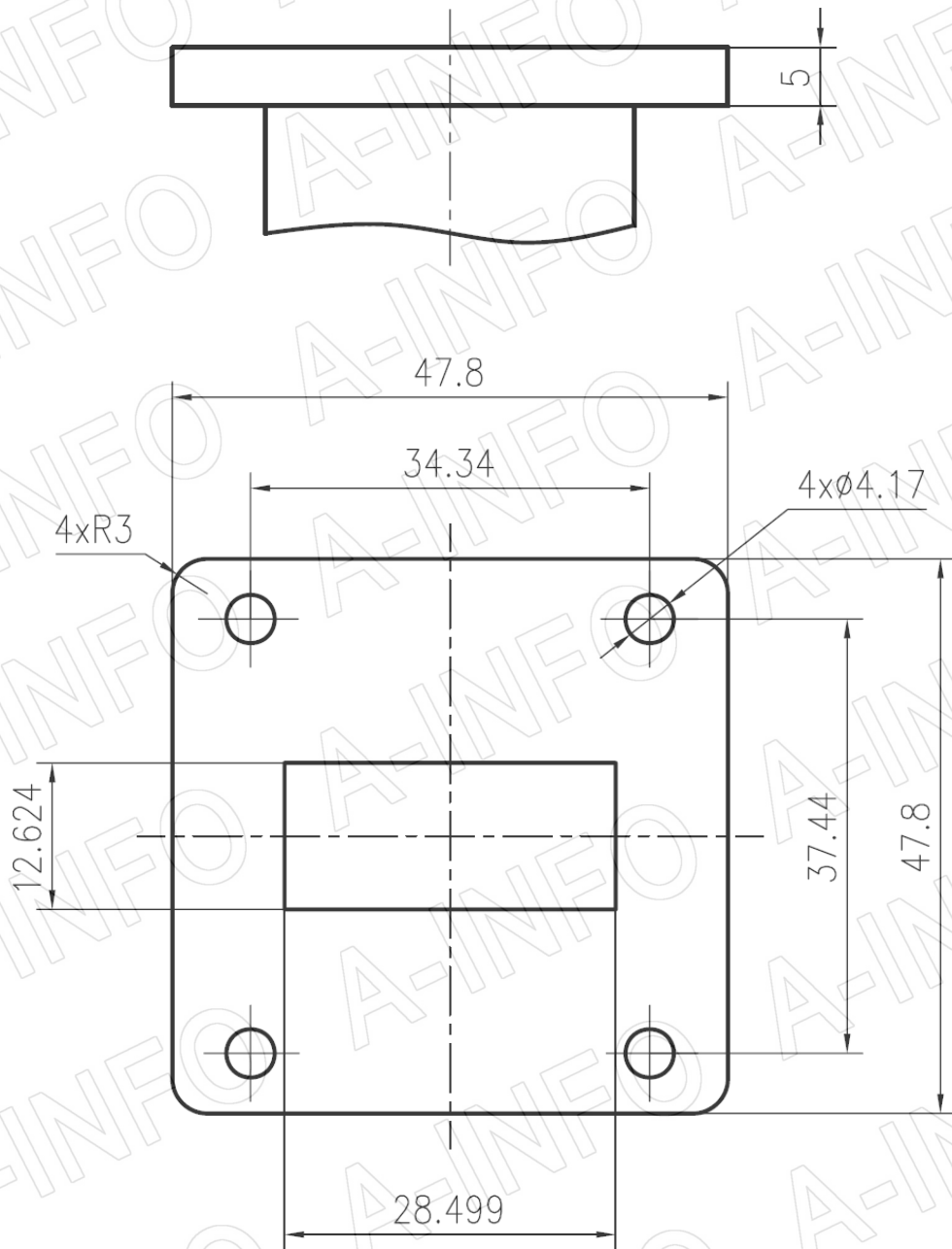

FBP84

AINFO Inc.

China(Beijing): Tel: (+86) 10-6266-7326,
China(Chengdu): Tel: (+86) 28-8519-2786,
USA : Tel: (+1) 949-639-9688,

Page 2 of 5

(+86) 10-6266-7327 Fax: (+86) 10-6266-7379
(+86) 28-8519-3044 Fax: (+86) 28-8519-3068
(+1) 949-639-9608 Fax: (+1) 949-639-9670

Website: www.ainfoinc.com
Email: sales@ainfoinc.com

Test Results

Coupling

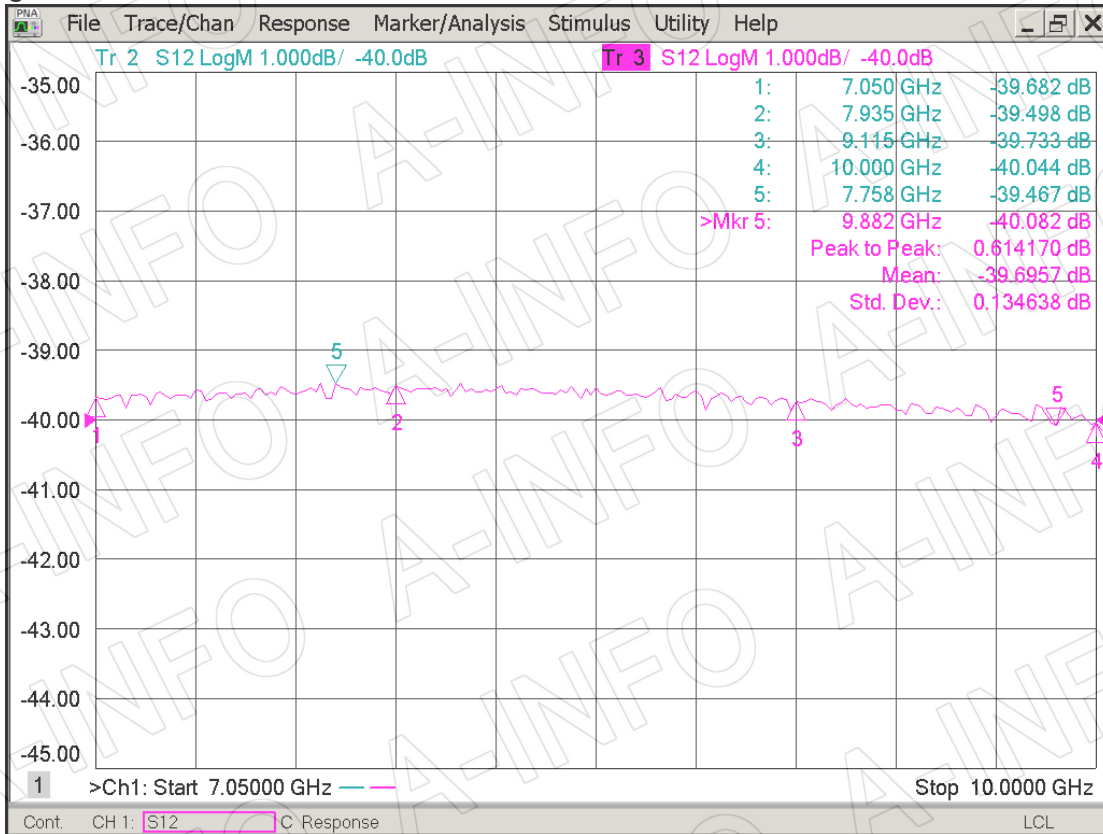

Directivity

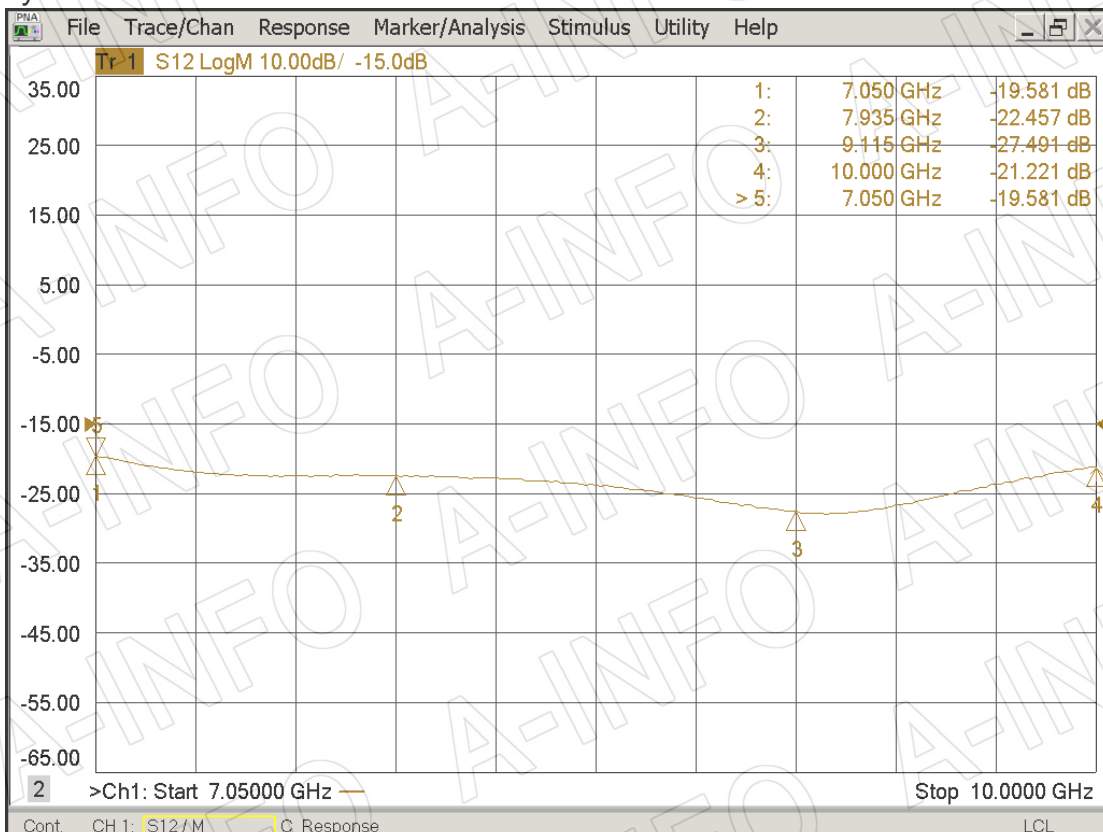

I.L. (Including the theoretical loss 4.34×10^{-4} dB)

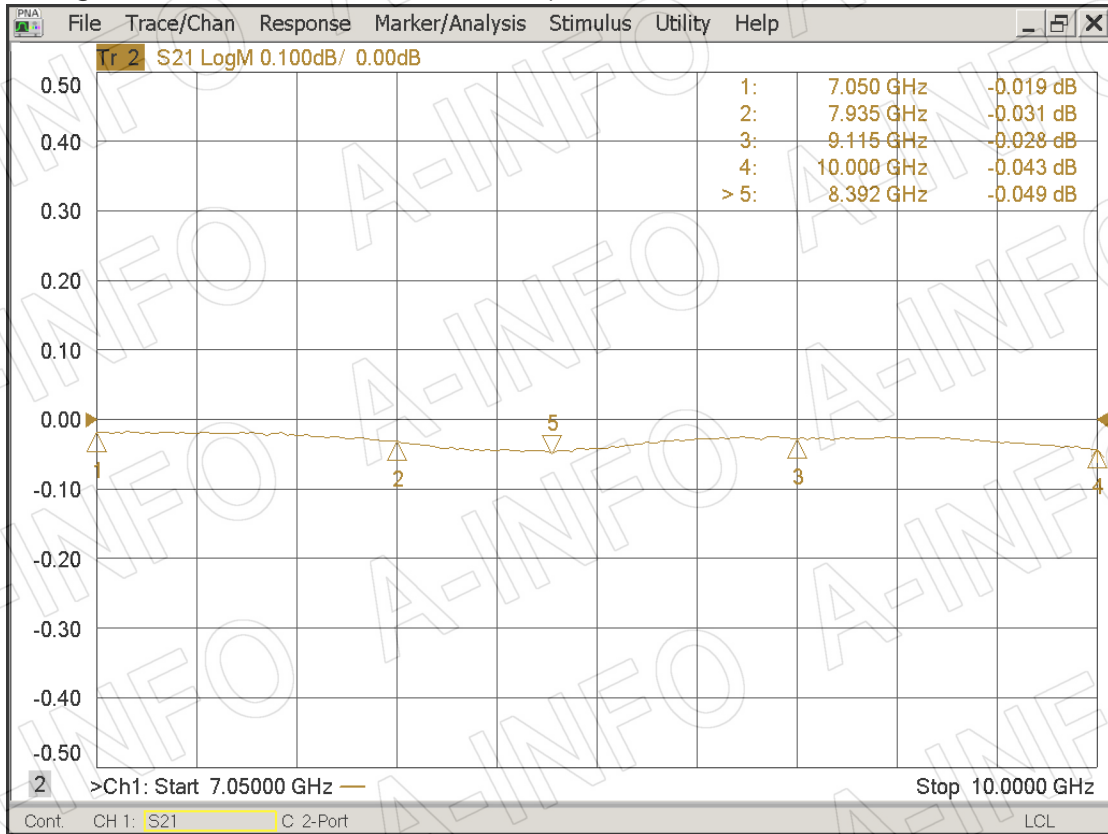

Mainline VSWR

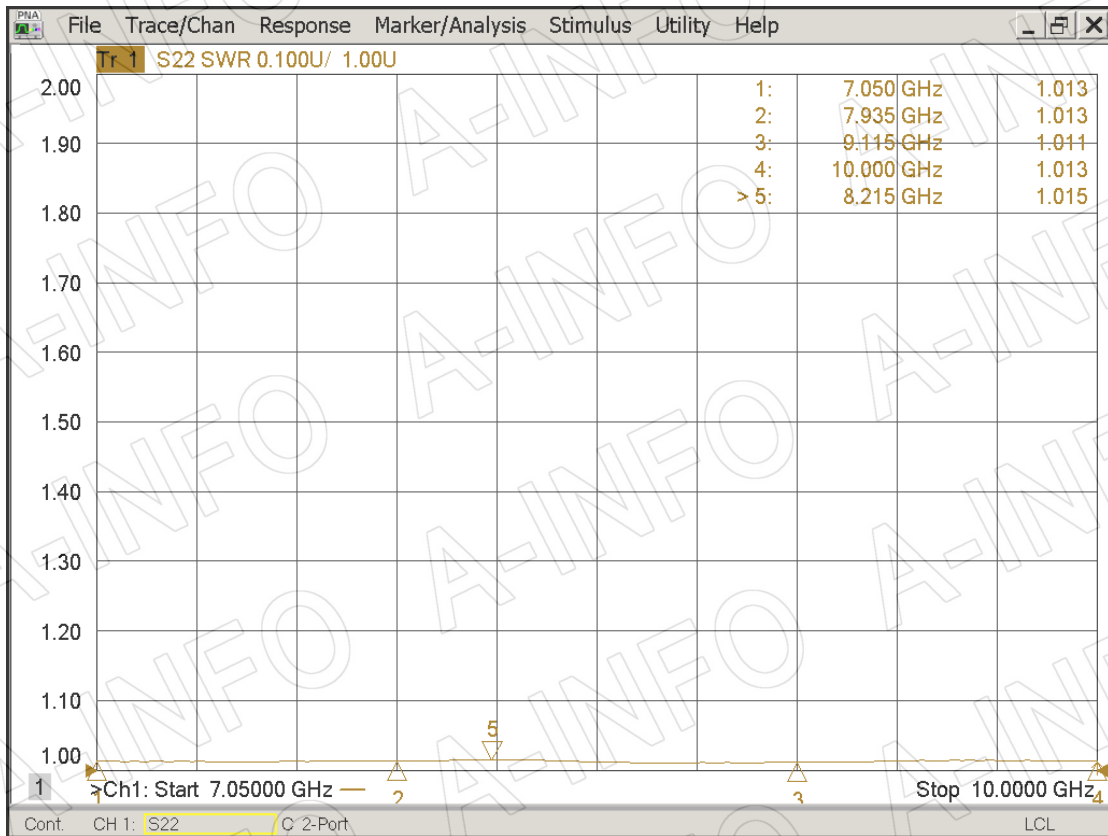

AINFO Inc.

China(Beijing): Tel: (+86) 10-6266-7326,
China(Chengdu): Tel: (+86) 28-8519-2786,
USA: Tel: (+1) 949-639-9688,

Page 4 of 5

(+86) 10-6266-7327 Fax: (+86) 10-6266-7379
(+86) 28-8519-3044 Fax: (+86) 28-8519-3068
(+1) 949-639-9608 Fax: (+1) 949-639-9670

Website: www.ainfoinc.com
Email: sales@ainfoinc.com

Secondline VSWR

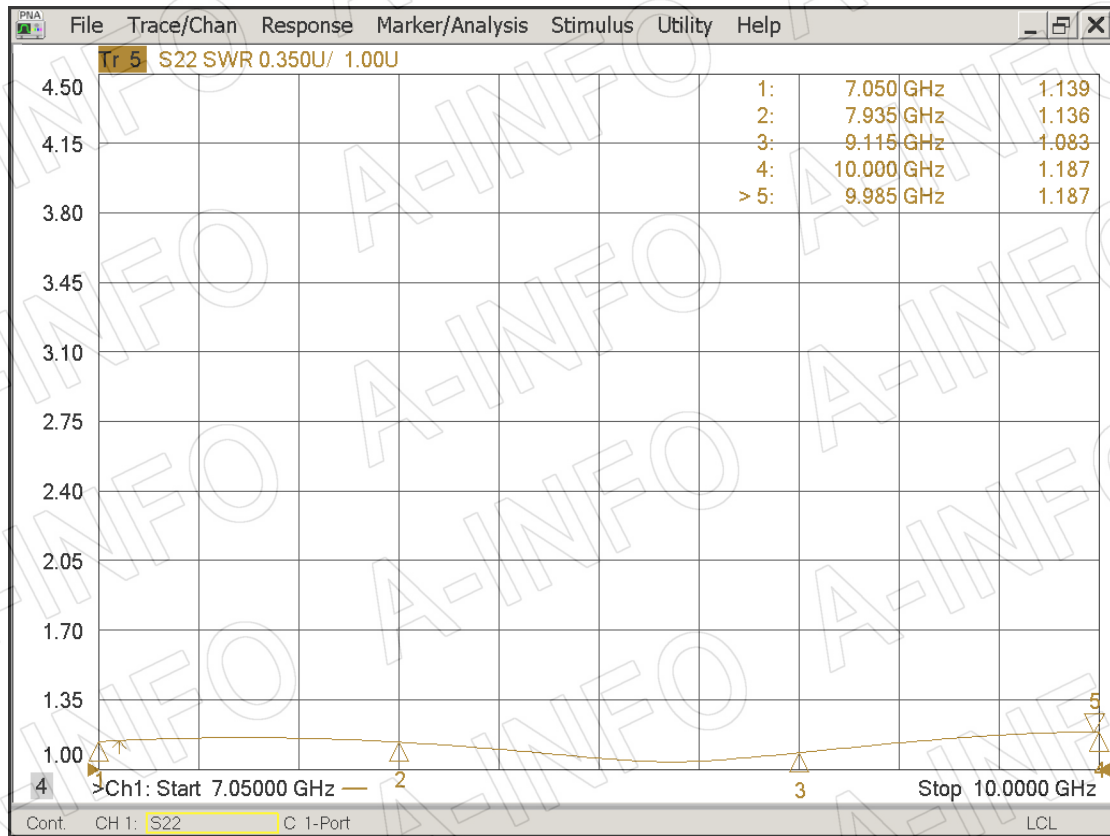

AINFO Inc.

China(Beijing): Tel: (+86) 10-6266-7326,
China(Chengdu): Tel: (+86) 28-8519-2786,
USA : Tel: (+1) 949-639-9688,

Page 5 of 5

(+86) 10-6266-7327 Fax: (+86) 10-6266-7379
(+86) 28-8519-3044 Fax: (+86) 28-8519-3068
(+1) 949-639-9608 Fax: (+1) 949-639-9670

Website: www.ainfoinc.com
Email: sales@ainfoinc.com